

Instructions for the use of Professional / Complete / Workshop and Economy Set

edited by Roger Koop

1. 0. General information on damage caused by stones on laminated windshields of motor vehicles and on **roger's** windshield repair system:

1. 1. The problem: Fractures on laminated windshields caused by stones.

1. 2. The solution: Repair of the damage using **roger's** windshield repair system instead of replacement, because ...

... damage caused by stones may be considered as a major defect in the legal test to extend the vehicle registration.

... a windshield fracture lowers the resale value of a used car.

... a vehicle with a fractured windshield might not be allowed to cross a international border.

... repairing a windshield is a much cheaper alternative to replacing it, and, from a macro-economic point of view, saves enormous amounts of money.

... most insurers will be happy to pay less for a windshield repair than for its replacement.

... the repair system is a modern alternative to throwing away damaged windshields, which can not be recycled, as this would not be profitable.

... most car repair shops can afford not take part in this trend (yearly more than 2.000.000 windshields will be repaired worldwide).

... with money saving repair a car repair shop will give greater satisfaction to at its customers, if the competitor offers only replacement. Such a customer will remember this the next time he has a problem with his car.

1. 3. The method: **roger's** windshield repair system: the most widespread, reliable and best equipped method of windshield repair. All fractures caused by the impact of stones - whether star fractures, cow's eyes, multiple and shattering fractures - can be easily repaired.

And the most best equipped tool sets for a comparable price - no competitor to **roger's** offers so many tools and materials in its sets for repairing all kinds of damages caused by stones .

The volume of the equipment parts are important, lastly, for the repair results and for what charges can be made for the repairs.

1. 4. Typical examples of damage to laminated glass:

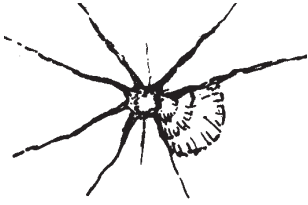

Star fracture



cow's eye



half cow's eye



multiple fracture

1. 5. roger's repair process (in simplified form):



1. The impact spot is cleared of dirt and loose glass fragments, ...



2. the **roger's** tool holder is fixed above the damaged spot, ...



3. the injection cylinder is screwed in and filled with **roger's** filling resin, ...

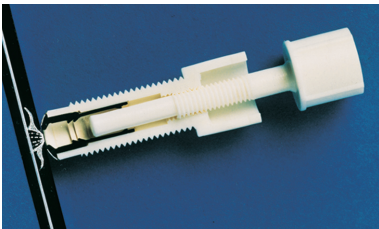

4. the **roger's** filling resin penetrates the damaged spot under pressure; air is vacuumed out, ...

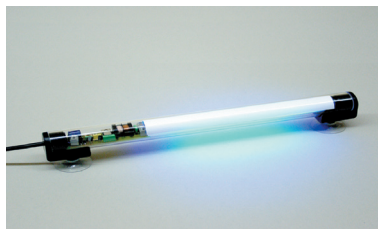

5. the **roger's** resin is cured under UV-light, making the damaged spot permanently glued, ...

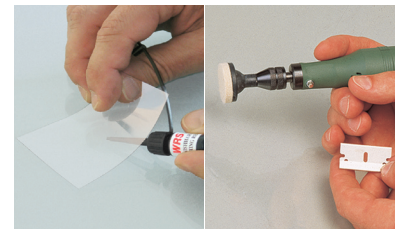

6. after applying finishing resin, the repaired spot is scraped and polished.

1. 6. Results of the repair:

Repairs carried out with **roger's** windshield repair system restore the windshield permanently. It is fully functional again and recovers all its original qualities, once again becoming

- tough
- shatterproof
- non-ageing
- thermally resistant
- chemically resistant
- wear-resistant

Any optical disturbance caused by the damage is eliminated - depending on the degree and the age of the damage - almost completely or at least to an acceptable degree.

1. 7. The outstanding quality of *roger's* repairs is due to:

- the world's best-equipped windshield repair equipment at the user's disposal, containing all tools and materials necessary to cope with any kind of fracture caused by stones.
- ***roger's*** special method of vacuuming the air out of the fracture.
- the unmatched spreading, moistening and adhesive power characteristics of ***roger's*** filling and finishing materials.
- the unequalled holding power of ***roger's*** adhesive materials.
- the ageing stability of ***roger's*** adhesive materials: there is no greying or yellowing and no opening up.
- a theoretical and practical training of the user by means of a comprehensive written and audio-visual repair documentation.
- a variety of special tools and materials for:
 - + wet, dirty or old fractures (wash primer and drying procedure)
 - + extensive shattering fractures of the surface (durable finishing resin even in large surface shattering fractures)
 - + fissures (crack stretching device and special adhesive tape)
 - + repairs of vertical bus and truck windshields (vertical or bus adapter)
 - + double impacts (special adhesive tape)
- and a refraction index of the filling and finishing materials identical with that of laminated windshields.

1. 8. *roger's* technology and development today:

roger's is not only at the top of the list of manufacturers of glass repair systems due to its excellent quality of materials and tools, but sets the pace for them.

This is due to ***roger's*** philosophy which was established in 1988, the year of the company's foundation:

On the one hand, the customer is not provided with a temporary, but with a permanent solution of his stone damage - which was not the case before due to the inadequate quality of the technologies on the market.

On the other hand, due to the high quality of ***roger's*** tools and materials, the user works with a widely accepted system, which means permanent profitable business for him.

Only some one who has done repairs with a „cheap“ system one which later goes yellow, gets reopenings, or grey, or from which the sealings break out; knows how much his own reputation will suffer from such bad repairs.

Because the customers connects the repair with the workshop and not with the system used.

Only with good repairs can you achieve customer satisfaction.

2. 0. Technical data about laminated glass and the effects of stone impacts on them:

2. 1. What are laminated windshields? What is their purpose and use?

For security and construction reasons, laminated windshields have been successful against the toughened-glass screens which only a couple of years ago were still used in some car types. These former toughened-glass screens consisted of a single bent and hardened float-glass screen of a thickness of 4 to 6 mm which used to break in thousands of tiny splinters when shattered.

The laminated windshield is a safety glass normally consisting of two layers of float-glass jointly bent in a bending oven. A polyvinyl butyral foil is pressed in-between them in a hot and vacuum condition. The function of the thermoplastic foil is to hold the individual broken pieces and splinters together when the windshield shatters, thereby reducing the danger of injuries to the passengers inside the car. After breaking or shattering, weblike fissuring occurs, but the whole structure remains intact.

Nowadays, the function of laminated windshields is not only to increase the safety of the car passengers, but as supporting structure of the car: they are not only inserted into the frame of the car body with a rubber sealing, but they are glued to it.

But this is exactly why the prices for the replacement of windshields have literally exploded. The average price for the replacement of a laminated passenger car windshield is today approx. Euro 500.- (without VAT), with a tendency to further increase.

2. 2. Technical data about laminated glass in motor vehicles:

Total thickness:	4.5 to 9 mm
Thickness of foil:	usually 0.8 mm
Thermal resistance:	90° C (for max. 30 min.)
Refraction index:	1.52

2. 3. The impact of stones on laminated windshields of motor vehicles and its effects:

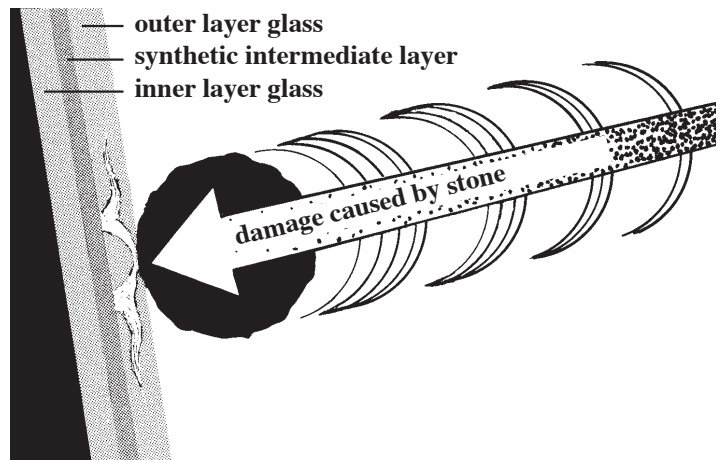

Sooner or later every stone impact means the end of the windshield:

- for single-layered hard-glass windshields, which are going out of use, it occurs immediately on impact
- for laminated windshields, it happens gradually, through:
 - + the formation of fissures from the impact of stones until the screen is completely fractured (caused by thermal tension, jolts, movement of the frame);
 - + penetration of damp;
 - + soiling of the impact spot due to the penetration of dirty rainwater or the use of thawing agents or car wash shampoos;
 - + coloration of the foils (due to the above mentioned reasons);
 - + loss of toughness and function (defects as defined by law);
 - + optical irritation of the driver (dazzlement during night drives).

Moreover, the windshield profile rubbers are damaged by constantly wiping over the impact spot, thereby leaving water stripes on the shield.

2. 4. Most frequent types of damage on laminated windshields:

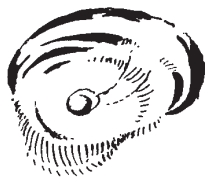

cow's eye



star fissure



half moon



multi fracture



full moon



shatter bubble

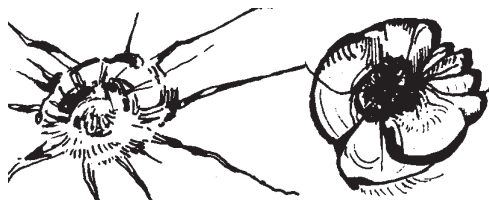

shatter fractures



double impact

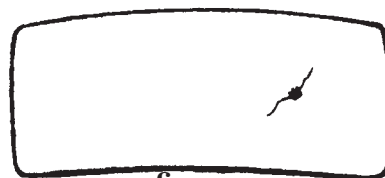

fissure

3. 0. Theory and requirements of repairs:

3. 1. General physics:

* Refraction index of different matters

air:	1.0
glass:	1.45 - 1.8
laminated glass:	1.52
water:	1.33
diamond:	2.4
roger's filling resin:	1.52

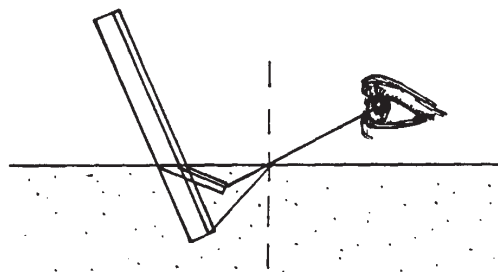

* Filling the damaged spots is primarily done through:

capillary action = the tendency of fluids to penetrate into narrowly adjacent areas or narrow tubes (fissures),

and

immersion = the filling of tiny air gaps in optically used areas with a fluid which has the same refraction index as the adjacent types of glass, so that the air gap behaves in an optically homogenous way, i.e. disappears when filled with the immersion fluid.

3. 2. Liability of the repair shop in case of failure to repair the damage or of fissure formation, either as a result of the stone impact or occurring during the repair or thereafter:

In principle, a windshield damaged by the impact of stones is considered a broken shield on which a repair attempt is made in order to avoid the expensive replacement of the whole windshield - which is necessary sooner or later - at a lower price.

Thus, in case of failure of the repair, the customer can refuse to pay it partly or in total (in case of failure, we recommend our users to voluntarily refuse payment).

The client is not entitled to a new windshield!

Should a fissure extend beyond the damage spot during the repair, then the principle, according to which the damaged windshield is considered broken, applies, although this may cause disagreement with the customer. We recommend to avoid critical repairs whenever they are identified as such, and to inform the customer about the risk involved.

The same applies whenever a fissure occurs after the repair, which is unlikely but not impossible.

In such a case, the customer can ask for reimbursement of the amount of the repair.

We recommend signing an agreement with the user's insurance company in case of stone damage, to cover such rare - but still possible - critical cases.

3. 3. Required repair results:

- enduring adhesiveness
- mechanical restoration of the toughness of the windshield
- no residual air (= optical impairment)
- a smooth and enduring surface (an additional advantage lies in the fact that the windshield wipers are not damaged by the impact spot; thus, no water stripes on the windshield)
- optically perfect repair work
- no subsequent greying, yellowing, opening up, or formation of fissures
- chemical and thermal restoration of the original qualities of the windshield
- ageing resistance of the repair work

3. 4. Requirements of the repair shop:

Ideal conditions for this kind of repair are in a hall or a garage with artificial light, because the adhesives set under UV-light. Therefore, there should be little exposure to daylight, which also contains UV-light (increasingly now, due to the expanding ozone hole over the northern hemisphere).

If work under daylight cannot be avoided, then it should be carried out in the shadow or by using the UV-protection foils contained in the tool case, which can be pulled over the tool-holder in order to protect the filling resin from being exposed to UV-light during the repair, which would cause its premature hardening.

Furthermore, temperatures above 35°C may soften the thermoplastic foil between the glass screens. As a consequence, filling resin may penetrate between foil and screen during the repair process, which may result in the formation of ghost edges and resin clouds.

Temperatures below 10°C may cause the material to thicken, which may give limited repair results because the resin is then not capable of penetrating the tiny fissures of the damaged spots, and the air cannot be completely removed by the thickened material.

4. 0. The repair procedure in practice:

4. 1. Preliminary inspection - examination of the basic conditions:

In order to determine whether to repair or not, a preliminary inspection should ascertain the following:

- * what kind of damage is it? Can it be repaired at all? Is there a fissure? How long and what degree of soiling?
- * what is the size of the damage? Large shattering fractures soil quickly.
- * is the damage dirty? This can be checked by holding a white and a black piece of paper against the damaged spot from inside the screen.
- * what is the general condition of the windshield as a whole? Edge delaminations and/or colorations indicate that the general condition of the laminated windshield is bad and that there is a high risk of overfilling.
- * where is the damage located? Observe the legal provisions.
- * and, last but not least, what type of car is it? The owner of a luxury car will have different criteria of quality than, for instance, a truck fleet manager: there is great variety in customers demands.

4. 2. Legal provisions excluding repairs:

“German law” has established a definition of the “far visual field”, in which no repairs may be carried out. This provision has been declared valid in most countries of the world.

It contains a restriction to carry out repairs in the following visual field of the windshield of a passenger car:

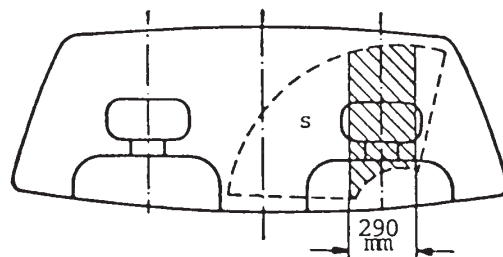

And similarly for truck and bus windshields:

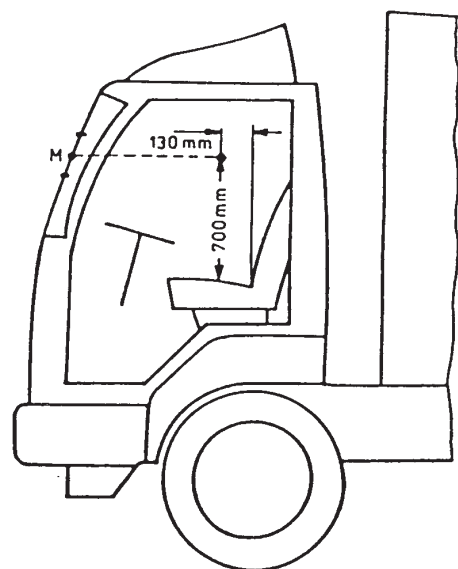
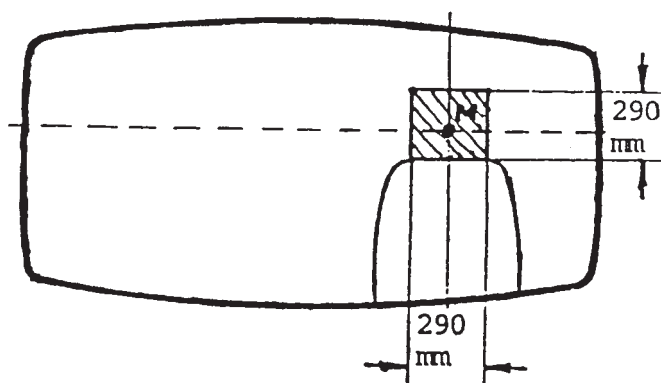

Detailed definitions are to be found in the “Verordnung 3001 of the TVK/60, Erg.Lfg. II/87” (“Regulation 3001”), which deals with the “Conditions for the repair of laminated windshields”.

In practice, the customer must be informed about the legal regulations, should the damage be within the restricted area of the “visual field”.

If the customer nevertheless wants the repair to be carried out on his own responsibility, then the bill has to state that there is no guarantee for the repair and that the repair shop is not liable, should the vehicle fail to pass the technical control test.

4. 3. Working temperature during the repair:

Note that the temperature of the windshield should be between +15°C and +30°C. Otherwise the windshield has to be either cooled down or heated up.

If the windshield is too cold in the cold season or in winter, let the car and the windshield defroster run for a while so as to heat it up from inside on the whole surface. Check the temperature by laying your hand on the windshield from outside.

In case it is summer and the windshield has heated up due to direct sun exposure, then the car should be placed in the shade or in a shaded area for a while. Again, warmth to the touch should be checked with the hand.

4. 4. Careful inspection of the damage:

After having decided to make a repair, a careful examination of the damage must be carried out:

- **dirt: hold a white and a black piece of paper against the damaged spot. A repair should only be made if the damaged spot doesn't show conspicuous soiling or greying - caused by water penetrating into the damaged spot - , because they usually cannot be removed even with a wash primer.**
- **dampness: can be determined by pressing the pusher - contained in the tool case - with pulsations against the centre of the impact cone: if there is water in the damaged spot, it can be seen flowing off and back in the exterior areas of the damage.**
- **ageing dirt: if it is not too heavy, treat it with a red washing cylinder and a wash primer - (included only in the Profi-/Complete-Set) detailed process description in section 4.6.**
- **is the damage to the outside or to the inside (which is rare, but sometimes occurs, mostly when it consists of fissures)?**

4. 5. Preparations and preliminary work:

- **clean the damaged spot and adjacent area (radius of 20 cm) with a cleaning paper and a normal glass cleaner available on the market. TAKE CARE not to let cleaning fluid get into the damaged spot (most of them contain silicone oil in order to clean without causing stripes!!!). Therefore it is recommendable to soak the cleaning paper with the glass cleaner instead of spraying it directly on the screen.**
- **fix the mirror, which is contained in the tool case, with a sucker on the inside of the windshield behind the damaged spot in such a way that the damage is clearly visible in the centre of the mirror from outside.**
- **carefully remove any loose glass splinters and surface dirt from the opening where the impact occurred by use of a carbide drawing pin (TAKE CARE not to make any scratches on the screen in the impact area, as this might impair the final result).**

- clear the impact spot - which will later absorb the filling resin - with the carbide drawing pin without increasing its diameter.
- some repair shops use carbide borers or drills for the removal of glass splinters and dirt!

4. 6. Cleaning and preparing damp, dirty or old damaged spots with the wash primer (included only in the Profi-/Complete-Set):

In order to achieve maximum cleaning and the required adhesive action, dirty and damp or old stone-impact damage (3 months or more) definitely should receive pre-treatment with the wash primer. Dry and freshly damaged spots may also receive this treatment.

It is easier to remove water, dirt or grease by using a wash primer than to dry it out with heat only. The wash primer increases adhesiveness by creating a cohesive chemical connection between the glass and the adhesive. Furthermore, it is never certain what kinds of different agents (thawing agent, car-wash shampoos etc.) have entered into the damaged spot prior to the repair. Therefore the wash primer is also recommended in case of dry damage.

Thus the wash primer preparatory procedure makes it possible to repair even old, wet and greasy damage and to improve already existing optical deterioration or impairment.

It must be made clear however that it is not possible to repair such damage to the same degree of optical quality as fresh damage. A considerable improvement is nevertheless possible by means of the washing primer.

Adhesive power according to tests carried out by **roger's** windshield repair system:

+ dry fresh damage <u>pre-treated with wash primer:</u>	over 600 kp/cm ²
+ dry, fresh damage <u>without preparatory treatment:</u>	approx. 500 kp/cm ²
+ old, dry damage <u>without preparatory treatment:</u>	200 - 400 kp/cm ²
+ damp or greasy damage or damage which was merely dried out, but <u>without preparatory treatment:</u>	50 - 150 kp/cm ²

Detailed instructions for use of the wash primer:

Take the red wash primer cylinder (included only in the Profi-/Complete-Set) out of the tool case and unscrew the injector screw. With a razor-blade, which you also find in the tool case, cut the screw thread off the injector screw to enable it to move back and forth inside the cylinder.

Now insert the injector screw into the cylinder: the bottom of the injector screw must reach the interior sealings of the cylinder. Check by looking from the bottom through the sealing into the cylinder.

Use one of the injection syringes of the tool case to push 0.3 - 0.4 ml wash primer into the red cylinder which you must hold upside down.

Centre the cylinder on the impact spot with the cylinder sealing until it gently touches the windshield. Hold it in this position with one hand.

With the other hand, carefully move the injector screw in and out against the cylinder, thereby pressing wash primer into the impact damaged spot and residual air out of it.

TAKE CARE not to exert too much pressure on the wash primer as this might force fluid between foil and glass!

After moving the injector screw in and out repeatedly, wash primer is pressed into the damaged spot and sucked out again, thereby washing it out. The wash primer binds water, grease and dirt, which are removed along with it.

At the same time, the damaged spot is physically stretched a bit and chemically prepared by improving the adhesiveness.

After approx. 30 - 60 seconds of washing, remove the cylinder and shake out the dirty wash primer on a cleaning paper.

Suck out the fluid mixture from the damaged spot using the vacuum pump (included only in the Profi-/Complete- and Workshop-Set), the PVC-hose and the transparent suction cup (included only in the Profi-/Complete-Set). Warm the rear side of the damaged spot with the car cigarette lighter heated up by the battery connection adapter.

As soon as the damaged spot is clearly discernable, remove the transparent suction cup and now warm the front side of the damage with the cigarette lighter in order to vaporize residual wash primer, until the damaged spot is completely dry.

With the trigger, exert a little pressure on the impact cone (as you would do with wet damage) to check if the wash primer is completely removed.

Depending on the type of impairment (dampness, age, dirt, grease) the procedures of washing with the wash primer, sucking it out with the vacuum pump, warming and vaporizing may be repeated, changing the wash primer every time. **TAKE CARE:** although the wash primer doesn't damage the varnish paint of the car, we do recommend that they do not come in contact. It is also highly inflammable!

The wash primer cylinder may be used repeatedly. Clean it from time to time by letting wash primer flow through it.

4. 7. Mounting the tool-holder:

Take the tool-holder out of the case and unscrew the suction cup by means of the lifting and lowering screw nut in the centre on top.

Lightly smear vacuum sealing agent around the edge of the suction cup. This has to be done in order to avoid the tool-holder slipping away during the repair process or even falling off the windshield under the effect of air suction, if by chance it has been fixed on a small unnoticed surface shattering fracture!

Fix the tool-holder with the suction cup - which has been moved out - adjacent to the damaged spot so that the centre of the ball-head - into which the filling-resin cylinder is later screwed - lies above the damaged spot itself.

Then screw down the lifting and lowering screw nut in the centre until the three feet of the tool-holder plate stay on the windshield, exerting only little pressure on it.

Take care that there is not too much pressure between the suction cup and the tool-holder plate as this might create new fissures moving out from the damaged spot or below the suction cup!!!

This is one of the most frequently made mistakes in the use of this system, and after some experience with it, the user realizes how little pressure on the suction cup is necessary to keep the tool-holder properly stuck on the windshield!!!

4. 8. 1. Mounting the filling-resin cylinder:

Take the filling-resin package out of the tool-case, cut off 1.5 cm of the broadside with a razor-blade or scissors and take the filling-resin cylinder out of the bag - for the time being, leave the filling-resin container in the bag.

Close the package again to protect its content from daylight. The filling-resin container should be exposed to daylight - which contains UV-light - as little as possible, as this may cause it to gelatinize or to polymerize, which makes it unusable!!!

Unscrew the injector screw from the cylinder.

Swivel the swivel arm approx. 2 cm to the left or right side away from the impact point.

* Beginners take the rubber sealing out of the filling-resin cylinder and screw it into the ball-head until the latter touches the windshield.

Now open the fixing nut of the ball-head and centre cylinder perpendicular to the windshield in order that the bottom cylinder opening touches it flush on its whole surface. Close the fixing nut of the ball-head again. Screw in the filling-resin cylinder again to adjust it. Check that the bottom opening of the cylinder is properly set on the windshield. If necessary, readjust by reopening the fixing nut and close it again.

Now unscrew the filling-resin cylinder and put the rubber sealing in the opening of the cylinder again.

Screw the filling-resin cylinder back into the ball-head until the rubber sealing almost touches the windshield showing dark, circular shading of the cylinder rubber resting on the windshield.

* Experienced users will screw in the filling resin cylinder including the cylinder sealant into the ball head until the sealant touches the glass surface slightly. Then they will open the fixing nut slightly and make the optimal adjustment of the filling-resin cylinder against the windshield (until the cylinder stands at a right angle to the glass surface). This is visible in the mirror as a dark, circular shading of the cylinder rubber resting on the windshield.

Then screw back the cylinder slightly. Swivel back the arm into its basic position. And if necessary a correction can be made now by slipping the whole tool-holder until the filling-resin cylinder is centred exactly above the impact spot.

This will be done as long until the cylinder is adjusted correctly to the impact point.

This can be checked by looking through the upper cylinder opening (into which the injector screw will be screwed later) down to the impact spot and to the mirror until the bore of the filling-resin cylinder is in line with the centre of the damaged spot.

The vacuum gel applied between suction cup and screen surface acts as a lubricant.

As soon as the seal of the filling-resin cylinder is centred exactly above the impact spot, carefully adjust the lifting and lowering screw nut of the suction cup (2 or 3 quarter-turns are enough!).

Now screw the filling-resin cylinder into the ball-head until the sealing rubber of the cylinder gently rests on the damaged spot. This is visible in the mirror as a dark, circular shading of the cylinder rubber resting on the screen.

If the impact spot is hard to see, you may wave the swivel arm of the filling-resin cylinder 2 - 3 cm in one or the other direction. The cylinder seal as it rests on the screen can be better observed from an adjacent clean area of the windshield.

Never overscrew the cylinder, thus pressing the sealing too tightly, as this may close up the opening of the impact spot, which will make it harder to fill in the resin and to suck off air, or even lead to the enlargement of old fissures or to the formation of new ones arising from the impact spot.

Until that it may can happen that by removing the pressure, the filling of the damage gets reopened in the upper areas after taking away the cylinder and while curing the resin.

4. 8. 2. Use of the bus adapter (included only in the Profi-/Complete-Set):

In case of repairs of vertical screens, the problem is that the filling resin isn't concentrated in the bottom of the cylinder, but dispersed in the bore of the injector screw. And the vacuum procedure can't be applied.

The tool-case contains a vertical or bus adapter to be used for vertical screens of trucks, buses and vans.

The tool-holder is applied on the screen as described in section 4.7.

But instead of the filling-resin cylinder, it is the bus adapter that is first screwed into the ball-head and centred perpendicularly against the screen (just like the normal filling-resin cylinder, as described in paragraphs 5 and 8 of section 4.8.1.).

As soon as the sealing of the bus adapter gently rests on the screen, adjust the bus adapter with the fixing nut of the ball-head and the counter nut, in such a way that the threaded opening in the upper part of the bus adapter, for the filling-resin cylinder points upward.

If such a twist of the bus adapter will be necessary, an after adjustment will have to be made again so that the bus adapter will be at last in a right angle position to the glass surface (as described in paragraphs 5 and 8 of section 4.8.1.).

As soon the bus adapter is adjusted correctly penetrate the needle as deeply as possible through the upper part of the bus adapter into the lower part until it touches the glass surface. Than inject 0.25 ml filling resin into the lower part of the bus adapter.

Again, stow the filling-resin containment, the syringe and the needle in the bag to keep them away from the daylight.

Now screw the filling-resin cylinder into the upper part of the bus adapter until its sealing properly rests on the bottom of the upper part of the bus adapter.

4. 9. Injection of filling-resin, first low-pressure phase:

Take out the filling resin container from the resin bag. Unscrew the red stopper from the container. Screw on the needle with its protective cover.

Cover the container with the orange socket to protect the resin against daylight.

Remove the needle cover from the needle, stick the needle into the cylinder as deep as possible. Inject into the cylinder (if the filling-resin cylinder has never been used before) 0.3 ml, otherwise 0.2 ml.

Remove the needle from the cylinder, hold the syringe upwards and remove the piston just enough to suck up all the resin from the needle into the syringe. Lay the syringe aside to avoid resin dropping out by laying.

Replace the needle cover on the needle. Stow the whole resin container in the resin bag to protect it from daylight. The resin container should be taken out of the bag only when needed.

Do not expose filling and finishing resin to the sun directly or indirectly (for instance repairs in halls near large and open gates), while they are in use. The increasing UV-radiation of the sun due to the growing ozone hole in the northern hemisphere may lead to premature hardening of the repair materials.

Screw the injector screw slowly into the cylinder until you can see that the filling resin enters the damaged spot. Don't give it too much pressure!!!

Observe this principle: The lower the pressure on the filling-resin, the better the repair result!

Take your time with the repair of this type of damage: after all, the whole procedure doesn't take longer than 40 to 60 minutes. Time is your best helper to get a really good repair!

Hasty repairs, made with a lot of manipulation, will not be as satisfactory as they could have been if more time had been taken.

As soon as two thirds of the damaged area is filled with resin, screw out the injector screw until the upper edge of its thread is visible at the upper edge of the cylinder.

The air at the edge of the damaged spot will move towards the centre and from there up into the cylinder. In this way you remove the largest air bubbles.

Wait a bit and then once more screw the injector screw into the cylinder and put the filling resin under pressure.

4. 10. Putting the damaged spot under vacuum with the help of the vacuum pump (included only in the Profi- /Complete- and Workshop-Set):

As soon as three quarters to four fifths of the damaged area is filled with resin, screw out the injector screw completely, insert the black connection piece of the PVC-hose of the hand vacuum pump into the upper part of the filling-resin cylinder and introduce a maximum vacuum (approx. 70 mbar residual pressure).

As a result of this procedure, an almost-vacuum situation is produced in the upper part of the cylinder, above the filling resin. At the same time, the air in the damaged spot is still under normal pressure (aprox. 1000 mbar) because it is locked by the filling resin (which, since it is physically heavier than air, cannot move upward).

This situation causes the air to expand inside the damage and to escape in the form of bubbles from the damaged spot and through the resin and cylinder.

In order to increase this effect, warm the damage 2 - 3 times from the rear side with the cigarette lighter which was heated up in the battery connection adapter (TAKE CARE: there are a very small number of cars, for instance the Porsche 956, whose windshields are coated with polycarbonate on the inside of the shield. This method cannot be used for the windshield of these cars as it would break them!!!). This causes the air to further expand and the resin to dilute a bit, which in turn makes it easier for the resin to penetrate into the smallest gaps of the damaged area after stopping the vacuum action.

Don't heat up the repair place too often, because that may soften the thermoplastic interlayer in between the glasses, and the next pressure phase filling resin may be pressed in between foil and glass. Which can create ghost rims and resin flowers next to the repair.

Remove the connection of the vacuum pump after 3 - 5 minutes. This brings the air pressure at the upper part of the cylinder back to a normal level. But inside the damaged area, the temporary vacuum has produced a state of near-vacuum which first existed in the upper part of the cylinder and led the filling resin in the lower part of the cylinder to move into the damaged areas.

roger's offers a 240 V vacuum-pump with a residual pressure of 1 mbar to repair-shops which carry out more than 100 repairs per month. This pump speeds up the air suction in the damaged area considerably and thus accelerates the repair process.

4. 11. Repetition of pressure and vacuum procedures:

Pressure and vacuum procedures should be repeated until the damaged spot, upon with draw all of the injector screw, is optimally and completely filled with resin (i.e. when there is neither pressure nor vacuum in it) and completely free of air bubbles, and remains so for 1 - 3 minutes.

4. 12. Visual inspection from all sides:

Swivel the tool-holder, with the filling-resin cylinder, 2 - 4 cm to the left or to the right and inspect the damaged spot from all sides.

Inspect from different angles in order not to overlook air bubbles still left in the damaged spot. If you don't get them out, they will remain locked up in the damage irrevocably and thus cause some residual irritation.

4. 13. Difficult cases: You can't get the air out completely - what can you do?



The most essential principle is: "It is more important to get the air out of the damage than to get the resin in!!!"

The most frequent mistake is to reverse this principle!!! Especially when they have little experience, users focus on pressing the resin into the damaged spot and fighting the air bubbles with too much manipulation, i.e. with too much heat and mechanical activity, which making the final repair result look bad!

In the case of so-called high-pressure repairs, air is often locked up at the edges of the damaged spots or even pressed between foil and glass which may later cause them to expand under sun exposure, so that you will have unremovable air bubbles around the damaged spot.

You have to bear in mind that the size of these cracks, fissures and detachments of glass caused by stones are in the range of hundredths and thousandths of millimetres, and it would be a miracle to fill them up with resin efficiently in no time.

Then what can you do if you have problems getting the air out?

- **Operate the vacuum pump by inserting it into the cylinder for a long time (10 minutes) and simultaneously warm the damaged spot with the cigarette lighter from the rear side, but only once or twice.**

You can hardly do anything wrong with vacuum.

The effect of warmth under vacuum is not as dangerous as under pressure, which may even lead to an overflow of resin (into the space between foil and glass) due to a softening of foil.

The cigarette lighter, which is heated by a battery connection adapter supplied with the tool-case, has the advantage against ordinary cigarette lighters, repair-shop or paint fans, that a lot of warmth is conveyed to the damaged spot from the rear side, but quickly escapes.

A main problem with glass is that it stores heat very well. But this may have disastrous effects in three ways:

1. **If the damaged spot has been heated for too long and over a surface too large, it is then compressed in on itself (cone of the damage against the surrounding glass surface) as a result of the heat expansion of glass. The repair may then look perfectly done and beautiful, but it isn't: after a premature hardening and the subsequent cooling, openings in the damaged parts may appear in consequence of the return of the glass to a normal temperature.**
2. **Applying too much heat and later exerting too much resin pressure may overflow the damaged spot and lead to ghost edges or resin clouds or even to resin flowers between the glass and the foil!**
3. **The filling material may coalesce, which makes it impossible to proceed to final treatment with the finishing resin.**

Applying heat and later strong pressure can completely ruin a windshield!

Therefore, stick to these main principles for a "beautiful" windshield repair:

- **take your time**
- **produce little pressure between the sucking cup and the tool holder**
- **exert little pressure from the sealing lip of the cylinder on the damaged spot**
- **work more with vacuum, less with pressure**
- **heat up the damaged spot moderately and let it cool off in between.**

- After the vacuum phase and prior to screwing in the injector screw again, exert slight pressure on the impact cone with the trigger through the cylinder opening. This has two effects:

The impact cone, which was sucked towards the surrounding glass, will be pushed back a bit.

Furthermore, this helps the filling resin to penetrate more easily into the damaged spot - which is still under vacuum - , and it will later help the residual air to get out.

- In case of a large damage area, check if there is enough resin in the cylinder! Work with 0.25 - 0.35 ml filling resin!
- Long but weak pressure stages, such as star-fractures with long fissures, or light damage with very small impact spots.
- Slight pressure with the trigger contained in the tool-case, on the fissures spreading out of the impact spot causes them to open slightly downward so as to enable the resin to enter.

With this procedure it can also be checked whether the fissures have been filled properly.

- Slight pressure from behind with the thumb or with the roger's crack stretching device (not included in the Sets, extra available special tool) against the damaged spot are possible.

But, for beginners, these are hazardous methods of correction because they can create new fissures.

- For cases where the connection between the impact spot and the underlying damage is too small or where there is no such connection (there are such cases!!), it is advisable to carefully bore a connection using the drill and the carbide bit and to strike with a punch and a drawing pin (as described under section 4.14).
- Curing under pressure should only be carried out if some tiny air bubbles are left which really can't be removed. This should be made laterally to the tool-holder and the filling-resin, under pressure, and it crushes the bubbles to invisibility.

Curing from the rear side doesn't work (in most cases) because the foil in the front screen contains a UV-protection additive which protects the interior of the car from damages caused by sun exposure!

- For the so-called two- and three-pedes (star-fractures), it often happens that one of the cracks or all of them don't have a connection with the impact spot. In such a case it is recommended to carefully bore a connection with the drill and the carbide bit and then to strike with a punch and a drawing pin (as described under section 4.14).
- For shattering fractures also, careful boring with the drilling machine and the carbide drill and striking into the cone with a punch and a drawing pin (as described under section 4.14) can be useful to enable the shattered parts inside the cone, which are full of tiny cracks, to better fill up with resin.
- The crack stretching device (not supplied with the tool-set) can be used to open up cracks and star-fractures under high pressure by exerting mechanical counter pressure on the damaged spot from behind.

But this is a risky method which should only be followed by experienced users!

4. 14. Boring of damage caused by stones and striking them with punch and drawing pin:

Some damage have little or no connection between the impact, which is sometimes invisible or imperceptible, and the underlying damage or the existing cracks. This makes it necessary to carefully bore with the drill and the carbide bit and then to strike into the damaged spot with a punch and a drawing pin (used as a striking tool due to its ideal weight).

The procedure is as follows: the carbide bit is inserted in the drill chuck.

- * If an impact is perceptible, a hole is bored in a right angle in its centre with very little pressure. Just until the glass comes out of the bore hole as white powder. Then the drill is withdrawn to cool down the carbide drill bit while rotating it for a bit.
- * If no impact can be discerned, first grind a small indentation above the centre of the impact spot, holding the drill at an angle of 30 - 45° to the windscreen. The drill is best handled if you hold it tightly in one hand, which supports itself on the screen, while the other hand guides it. Whilst the drill bit is moved down slowly to the glass surface.

It's quite important to hold the drill firmly and to move the drill bit down slowly to the glass surface to avoid a side slipping over the glass surface which would create ugly and not really repairable extra damages.

As soon an initial bore hole has been created, further boring can proceed at a right angle in its centre with very little pressure. Estimate so long until the glass comes out of the bore hole as white powder. Then the drill is withdrawn to cool down the carbide drill bit while rotating it for a bit.

But please bear in mind that the state of aggregation of glass is semifluid, which means that if boring goes on too long or if too much pressure is exerted on the drill, the high temperatures may cause the glass to melt (which in turn glues the drill disks).

Boring should almost reach the foil of the screen (the thickness of the outer layer of glass is usually 1.9-2 mm for passenger cars and 2.5-3 mm for trucks, vans and buses).

Don't bore into the foil!! Because this will create yellow or brown foil burns (train yourself with an old windshield to get some practice!)

Then, with the punch and the drawing pin (which has the ideal weight for this kind of exercise), carefully strike a small cow's eye on the bottom of the boring axially into the impact spot.

4. 15. Final inspection:

Swing the swivel arm with the ball-head aside and wait for 1 or 2 minutes to see if air bubbles appear from the edge.

Before proceeding with curing, it is imperative that there are no bubbles left: not only do they look ugly on the windshield and remain there forever, but the polymerization shrinkage during the hardening process makes them even grow!

Moreover, the damage should be filled “to saturation” and not overfilled. In such a way, a certain body of resin will remain on the spot despite the polymerization shrinkage during the hardening process, and there will be no appearance of iridescent surfaces on the formerly damaged spot, no detachments, and no grey or silver moons on the edge of the former damage area.

4.16. Curing of the filling resin:

When the damage is perfectly filled and no further changes in the filling have occurred, suck off the resin remaining in the cylinder, with the reserve resin syringe and needle.

Keep the filling-resin syringe in its pack and protect it from daylight. The material inside the syringe can be used for the next repair.

Take off the tool-holder! Remove the water-soluble vacuum-gel left in the suction cup with cleaning paper and water.

Use the razor blade contained in the tool-case to cut off remaining resin from the impact spot 2 - 4 times.

Cure the repair work for 2 - 3 minutes using the UV-lamp!

Note: the 6 W UV-tube has a maximum working life of 2,000 hours, but it emits UV-rays in the range required only for a period of 1,000 hours. Thereafter the tube produces no curing effect anymore, although it still emits light. Replace the tube with the reserve tube (included only in the Profi-/Complete-Set) in the tool-case.

TAKE CARE not to turn on the lamp without tube or with an old, flickering tube, as this may destroy the power transistor - despite its sophisticated electronics - and occasion unnecessary repair costs.

4.17. Impact-spot or surface sealing with the finishing resin:

The competition has no or no adequate materials for surface sealing.

Either they fill up the surface shattering fractures with filling-resin, which is inappropriate and cracks after a while.

Or they offer finishing-resins for surface sealing, which soon turn grey or yellow and crack after max. 3 - 6 months.

The surface sealing is not only an important part of finishing good stone damage repair. It must remain transparent for years, be definitely durable and not change in any way. In this way the stone damage repair will be a really acceptable alternative to the changing of windshields.

A repair which turns yellow, whose surface sealing will burst out again irritates the driver, just like the unrepaired stone damage.

What is worse is that it has not restored the physical firmness of the windshield. And it also does not fulfil the optical claims. More over the requirements of the law have not been met (keyword: yearly inspection).

roger's has developed a finishing-resin based on technology of the Austrian ski industry. This industry requires a high level of permanent flexibility of the basic components as well as lack of yellowing or brittleness for the ski products which are used in areas with high UV-exposure (mountains have a much higher UV-exposure than other areas). This resin doesn't turn grey or yellow and doesn't crack even in areas suffering from increased UV-radiation such as New-Zealand, southern Australia, southern Argentina and southern Chile.

Even large shattering fractures of the size of a thumb-nail can be permanently repaired with this resin.

- Minor shattering fractures can be attended as a whole by completely filling them with finishing resin. But take care to remove even small air bubbles with f.i. the trigger before the cure process, as they are growing during curing.
- The removal of air bubbles can be checked by exerting vacuum on the finishing resin via the suction cup connected to the vacuum pump by a PVC-hose. After a complete removal of all bubbles, slowly cover the finishing resin with finishing foil (to avoid small bubbles developing again) and let it cure under the UV-light for 2 - 3 minutes.
- In case of deeper (more than 0.5 mm) surface shattering fractures, the finishing resin must be applied in layers of approx. 0.5 mm.

Again take care to have all bubbles completely removed.

Let each layer cure for 1 minute - without finish foil.

Before bringing on the last finishing resin layer use the razor blade to cut off remaining resin from the impact spot 2 - 3 times.

Now cover the last layer, which completely fills up the surface shattering fracture, with a finishing foil and let it cure for 2 - 3 minutes.

* Sealing of boring holes - see section 4.18!!

4. 18. Sealing of boring holes:

Fill boring holes with finishing resin (as shown in the illustration below) in several stages and let them cure after every filling.

If such a boring hole is filled and later cured all at once, the material inside cures from top to bottom due to the decreasing intensity of radiation going the same way. As soon as the top has cured, no more resin can flow into the hole anymore, and this produces a vacuum bubble in the bottom of the hole due to the polymerization shrinkage!

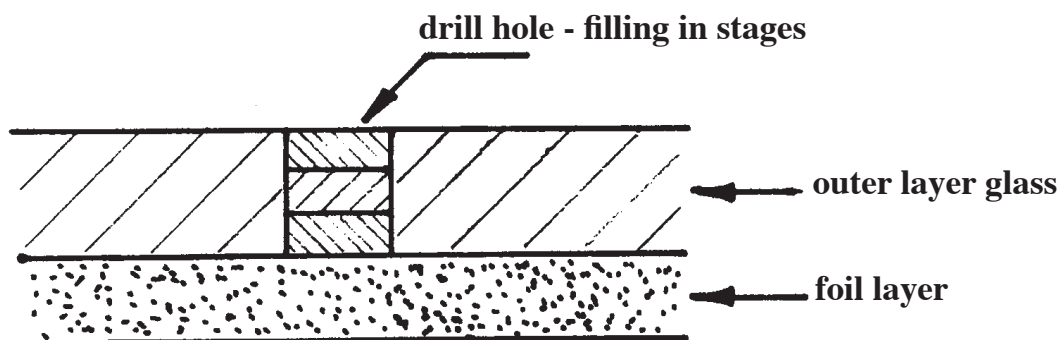

4. 19. Final work:

Remove the UV-lamp, peel off the finishing foil (wipe off the remaining resin from the foil, since it can always be reused!)

Now remove remnants of the resin from the windshields using the razor blade crosswise in an angle of approx. 80°. Shave, but **DON'T CUT!**

Better less and carefully than too much and violently, in order not to make scratches on or pit the surface. Because a pit sealant can't be polished up.

Such a „staying grey effect“ is one of the most frequently made and claimed working mistakes.

Polish up the finishing resin using polish, polishing disk and drill. **DO NOT press too hard on the polishing disk**, otherwise the repair work will be heated up by heat due to friction!

5. 0. Repair of fissures:

5. 1. General information:

Generally speaking, **roger's** windshield repair system is a system to repair damages caused by stones rather than to repair fissures - which is not only valid for the **roger's** system, but for all systems available on the market. Some suppliers of windshield repair systems claim the opposite in order to sell their systems.

Not that you could bring the resin into the fissures. And that fresh fissures aren't repairable or that the adhesive power would not be high enough. Indeed you definitely can repair fissures lastingly. But in practice there are limits to it. Because:

1. most fissures are full of dirt. Because most fissures don't spread out from the impact spot instantly, with the client having them repaired right away, but they creep slowly, dirt penetrates into them, and clients usually come for a repair when it's already too late.
2. if fissures become longer or come out or end in the windshield edge, a kink is created in the surface which stays there, when the fissure has been repaired - which can be verified by looking parallel above the glass surface where the fissure repair has been done. This never fulfils the law requirements, especially the ECE R 43 regulation (which describes what characteristics a windshield has to fulfil).

Therefore, in practice only fissures of max. 10 cm length (passenger cars) and 30 cm length (trucks, vans and buses) can be repaired.

Longer fissures are bored at the ends, but not filled.

5. 2. Boring of fissures:

For passenger cars, most of the time it is not necessary (by the way that not longer fissures than max. 10 cm long will be repaired) to bore out fissures spreading out from the impact spot. They are completely filled on the basis of capillary action by dropping filling resin into the fissure parts which are not yet filled by the resin applied on the impact spot.

However, fissures of more than 10 cm length (at buses, trucks and vans) should be bored out at their end.

The procedure is as follows: the carbide bit is inserted in the drill chuck of the drill.

Then a small indentation is ground at a distance of 1 - 1.5 mm from the end of the fissure at an angle of 30 - 45° to the windshield. The drill is best handled if you hold it tightly in one hand, which supports itself on the screen, while the other hand guides it, while the drill bit is moved down slowly to the glass surface.

As soon as an initial bore hole has been created, the further boring should be at a right angle in its centre with very little pressure, Just until the glass comes out of the bore hole as white powder. Than the drill is withdrawn to cool down the carbide drill bit while rotating for a little bit.

But please bear in mind that the state of aggregation of glass is semifluid, which means that if boring takes too long or if too much pressure is exerted on the drill, the high temperatures may cause the glass to melt (which in turn glues the drill disks).

Boring should almost reach the foil of the screen (the thickness of the outer layer of glass is usually 1.9-2 mm for passenger cars and 2.5-3 mm for trucks, vans and buses.

Don't bore into the foil!! Because this will create yellow and brown foil burns (train yourself with an old windshield to get some practice!)

Then, with the punch and the drawing pin (which has the ideal weight for this kind of exercise), carefully strike a small cow's eye on the bottom of the boring axially into the impact spot.

5. 3. Sealing of fissure borings:

Fill boring holes with finishing resin (as shown in the illustration on page 19 under section 4.18.) in several stages and let them cure after every filling.

If such a boring is filled and later hardened all at once, the material in the hole hardens from top to bottom due to the decreasing intensity of radiation going the same way. As soon as the top has hardened, no more resin can flow into the hole anymore, and this may produce a vacuum bubble in the bottom of the hole due to the polymerization shrinkage!

5. 4. Filling fissures with resin:

The easiest method of filling fissures with resin is to take advantage of their capillary action.

With vertical fissures, one begins at the bottom and gradually fills them up.

With horizontal fissures, it doesn't matter where one begins, but if a stone-impact has occurred - which was usually repaired first - , it is normally begun at the other end.

The fissure should be filled up by using the dropper of the resin container, but only as long as the resin completely penetrates and the air escapes. Only then should the next drop go into the next part of the fissure. This is done to avoid air bubbles.

This method works fine with fresh fissures and gives good results.

However, depending on the pressing of the fissure, even fresh fissures may fill up too slowly. In such a case, exert a little pressure with the thumb or with **roger's** crack stretching device (not included in the Sets, extra available special tool) on the rear side of the damaged spot to improve the situation.

Due to its increased risk, only experienced persons should use this method.

After filling, the adhesive tape is stuck over the fissure to enable it to cure.

Thereafter, remove the adhesive tape again and use the razor blade to cut off left-over resin.

Old fissures which have already been damp and/or in which silicone or grease have been deposited, usually start filling up nicely at first, but then bubbles turn up, or the fissures don't accept the resin. In this case we have to estimate the creatable repair result!

Fresh fissures can often be repaired so well as to become almost invisible. But a penetration of water - even if occurred only once - will deteriorate the final repair result. Therefore, one can imagine the repair result of an old and dirty fissure. Cleaning the fissure with washprimer is mostly hopeless. With old fissures the optical improvement is not more than 75 % or less.

On the other hand the optical improvement is often less important, f.i. in the case of the panorama windscreens of buses, as compared with passenger cars.

Especially if the damage is not in the visual field and you consider the price of a windscreen replacement.

Very often, stopping the fissure will be of prime importance, and the optical improvement will come second. For the customer, cost-saving outweighs aesthetic appearance.

In such cases, method no. 2 is used: filling a fissure which has filled up badly or in which bubbles have formed.

Take the filling-resin cylinder and unscrew the injector screw until the upper part of its thread aligns with the upper edge of the cylinder. Then fill approx. 0.5 ml filling resin into the cylinder, head held first, using the resin syringe.

Apply the cylinder on the fissure spot and press gently with one hand. Screw in the injector screw and exert light pressure on the resin until you see that it penetrates into the fissure.

Now move the cylinder along the fissure while continuing to screw the injector screw in until you see that the resin enters into the fissure and that bubbles are forced out by the penetrating resin.

Especially at that methode is a mechanical pressure from the backside against the crack in the frontside with the **roger's** crack stretching device (not included in the Sets, extra available special tool) useful.

After a successful filling, the adhesive tape is stuck over the fissure to enable it to cure.

Thereafter, remove the adhesive tape again and use the razor blade to cut off left-over resin.

A third method of repairing fissures is to use a special adhesive tape which has particularly good adhesiveness and is resistant to resins for a certain time.

After drilling, the adhesive tape is centrally stuck over the fissure (avoiding the formation of air pockets) and lightly smoothed down. A hole is made with the drawing pin through the tape at the place where the drilling was done.

Now the tool-holder is attached as in the case of a stone-impact spot. The filling-resin cylinder is screwed in and placed over the drill hole, with the sealing gently resting on the damage. Fill the cylinder with 0.3 ml filling resin (use 0.5 ml for bus windshields in order to avoid pressing air into the fissure). If necessary, refill with resin! Now put the resin under pressure using the injector screw, whereby the resin is pressed into the fissure like into a pipe.

Also with this methode, a mechanical pressure from the back against the crack in the front with the *roger's* crack stretching device (not included in the Sets, extra available special tool) can be useful.

After the fissure has been completely filled - whether the whole fissure or sections of it - , remove the tool-holder. Peel off the adhesive tape only after the fissure has hardened.

Scrape off the remains of the resin with the razor blade, seal the boring holes with finishing resin (as described in section 4.18. Sealing of boring holes) and then polish.

6. 0. Types of damage / special repair and boring instructions:



Full moon

full moon ring has no connection to surface; boring required



Double impact

when close together: special adapter. If not: adhesive tape over both impacts and fill through a hole in the tape



Half-moon with no connection to impact hole

carbide boring into fissure. Impact spot treated separately



Half cow's eye badly fillable by heavy pressure:

carbide-bore in impact hole, strike open with punch

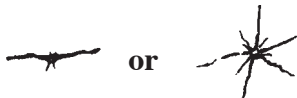

Small impact with star-cracks, with strong pressing or none at all:

bore in fissure, strike open with punch



Large shattering fractures: special adapter or adhesive tape, then cure (if necessary, under pressure)



Air pocket at edge:

vacuum and warmth from the rear side



Air pocket at centre:

vacuum stage and warmth from the rear side



Half-moon with fissures:

fill slowly, perhaps boring and striking with punch required

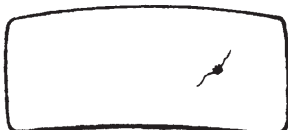

Fissure:

capillary filling or filling by use of adhesive tape; After boring, perhaps cure under pressure

7. 0. Summary of the instructions for use:

3. 4. Requirements for the repair shop:

- * whenever possible, work in a hall or garage with artificial light
- * if work under daylight cannot be avoided, use UV-protection foil.

4. 1. Preliminary inspection - examination of the basic conditions:

- * what kind of damage?
- * size of the damage?
- * Degree of soiling
- * condition of the windshield - edge delaminations and/or colorations
- * quality requirements - type of car in relation to size of damage

4. 2. Legal provisions excluding repairs:

- * do not repair in the “visual field” of cars, trucks and buses.

4. 3. Working temperature during the repair: +15°C to +30°C:

4. 4. Careful inspection of the damage:

- * damage to the outside or to the inside?
- * determine exactly the degree of soiling
- * dampness?
- * age?
- * find out if pre-treatment with wash primer necessary

4. 5. Preparations and preliminary work:

- * clean windshield adjacent to damaged spot
- * fix the mirror on the rear side of the damaged spot
- * remove glass splinters and dirt from the impact by use of a drawing pin

4. 6. Cleaning damp, dirty or old damaged spots with the red wash primer cylinder and the wash primer:

- * Cut the screw thread off the red injector screw with a razor blade, then insert it again into the cylinder
- * fill 0.3 - 0.4 ml wash primer into the cylinder held upside down
- * centre the cylinder on the impact spot with cylinder sealing and press wash primer in by moving injector screw in and out
- * repeat procedure when damage is completely filled with wash primer: this rinses the damage, has a cleaning effect and improves the adhesiveness
- * after 30 sec. of rinsing, remove cylinder and put damage under vacuum, using vacuum pump, PVC-hose and transparent suction cup. Simultaneously, heat up the damage from the rear side with the cigarette lighter.
- * as soon as the damaged spot is clearly discernable, stop the vacuum and now warm the front side of the damage with the cigarette lighter until it is completely dry.
- * check by exerting a little pressure with the trigger on the impact cone (as you would do with wet damage)
- * repeat procedure if necessary

4. 7. Mounting the tool-holder:

- * bring suction cup in position
- * smear vacuum sealing agent around the edge of the suction cup
- * fix the tool-holder on the screen so that the centre of the ball-head lies exactly above the damaged spot
- * screw down the lifting and lowering screw until the three feet of the tool-holder plate stay on the windshield. Don't screw down too much!

4. 8. 1. Mounting the filling-resin cylinder:

- * open filling-resin package; for the time being, take only the filling-resin cylinder out of the package. Close package, protect filling-resin containment from daylight
- * unscrew injector screw from cylinder and take the rubber sealing out of the cylinder
- * screw filling-resin cylinder into the ball-head until its bottom opening almost touches the windshield
- * open the fixing nut; cylinder is centred vertically to the windshield in order that the bottom cylinder opening touches it flush; screw down fixation screw nut again
- * readjust the cylinder and check if the bottom opening still sits close on the windshield. If not, open the fixing nut once more, readjust the cylinder and close the fixing screw again
- * screw cylinder out of the ball-head again and press the sealing rubber into the cylinder
- * wave swivel arm of filling-resin cylinder 2 - 3 cm and screw the latter into the ball-head until the rubber sealing gently rests on the screen. Then go back into the initial position
- * Check that the bore of the filling-resin cylinder is in line with the centre of the damaged spot by looking through the upper cylinder opening. If necessary, a correction can be made by slipping the whole tool-holder
- * Carefully adjust the lifting screw nut of the suction cup (2 or 3 quarter turns are enough!)

4. 8. 2. Use of the bus adapter:

- * in case of repairs of vertical screens, vertically adjust the filling-resin cylinder. Then screw the bus adapter (not the filling-resin cylinder) into the ball-head, until its sealing gently rests on the screen. Then return with swivel arm to initial position
- * adjust bus adapter with fixing the nut of the ball-head and the counter nut in such a way that the opening in the upper part of the bus adapter to screw the filling-resin cylinder in, points upwards
- * now inject 0.25 ml filling resin as deeply as possible into the bore of the bus adapter
- * screw the filling-resin cylinder into the bus adapter until its sealing rests on the screen

4. 9. Filling-resin injection:

- * inject resin into the cylinder (0.3 ml if the filling-resin cylinder has never been used before, otherwise 0.2 ml)
- * stow resin container to protect it from daylight!
- * screw injector screw into the cylinder until you can see that the filling resin enters the damaged spot. Don't give it too much pressure! Take your time!
- * as soon as two thirds to three quarters of the damaged parts are filled with resin, screw out the injector screw: this will cause most of the air in the damage to escape through the cylinder
- * repetition of the pressure and vacuum procedure

4. 10. Putting the damaged spot under vacuum:

- * as soon as three quarters to four fifths of the damaged spot are filled, screw out the injector screw completely, produce vacuum in the cylinder by means of a connection piece, a hose and the vacuum pump
- * warm the damage once or twice - not more often - with the cigarette lighter from the rear side
- * remove the vacuum after 5 minutes. The damaged area is in a vacuum state now, the cylinder has a normal air pressure again. This situation occasions the resin to be literally sucked into the damaged areas. In most cases, light pressure with the injector screw helps to fill the damage completely

4. 11. Repetition of pressure and vacuum procedures:

- * until damage is completely filled

4. 12. Visual inspection:

- * from all sides and different angles

4. 13. Difficult cases: How can you help yourself?

- * put cylinder under vacuum for a long time
- * thereafter, exert slight pressure on the resin and, consequently, on the impact with the trigger through the cylinder
- * in case of large damages: is there enough resin in the cylinder?
- * keep minimum pressure stages, but for a long time
- * exert pressure on the damaged spot with thumb or crack stretching device from behind. But be careful!!!
- * if there is little or no connection to the damage or to some fissures, bore and strike using punch and drawing pin
- * cure under pressure - curing from behind doesn't work in most case

4. 14. Boring of damages caused by stones and striking with punch and drawing pin:

- * insert carbide bit in drill chuck
- * if an impact is perceptible, a hole is vertically bored in it slowly and with very little pressure. After each boring, the drill is withdrawn to cool down. Don't bore into the foil!!
- * if no impact can be seen, first grind a small indentation on the spot where you will later bore (hold the drill angularly); then bore vertically; act slowly and exert little pressure. After each boring, the drill is withdrawn to cool down. Don't bore into the foil!!

4. 15. Final inspection:

- * wave swivel arm aside and check if the damage is really filled up and that there is no air left over
- * wait for a minute, then prepare for curing

4. 16. Curing of the filling resin:

- * drawoff the filling resin remaining in the cylinder, with the resin syringe and needle. Don't put it back into the filling-resin container
- * take off the tool-holder; clean suction cup from vacuum-gel
- * use razor blade to cut off remaining resin from the impact spot
- * cure the resin for 2 - 3 minutes using the UV-lamp

4. 17. Surface sealing with the finishing resin:

- * apply small quantities of finishing resin on the impact spot:
 - in case of minor damages, fill the hole at once;
 - in case of deeper damages, apply in layers (each layer must cured separately)
- * take care to remove all air bubbles before starting the hardening process
- * before curing, cut off remaining finishing resin with razor blade
- * the different layers of finishing resin are cured without finishing foil, only the last layer is always covered with finishing foil.

4. 18. Sealing of boring holes:

- * Boring holes and large surface splinter damages must always be filled and hardened in stages, otherwise vacuum bubbles will appear at the bottom of the finishing resin.

4. 19. Final work:

- * peel off and clean the finishing foil as it will be reused
- * scrape off remnants of the finishing resin crosswise with razor blade (exert only little pressure in order not to make scratches); don't cut off left over finishing resin!!!
- * polish up the finishing resin using polish, polishing disk and drill.

5. 0. Repair of fissures:

5. 2. Boring of fissures:

Boring is only necessary in case of fissures of more than 10 cm length.
This is done as follows:

- * the carbide drill is held at an angle to windscreen and a small indentation is ground at a distance of 1 - 1.5 mm from the end of the fissure
- * then bore vertically into the windshield. Bore for 1 sec., remove for 1 sec. for cooling
- * do not bore as deep as the screen foil, stop just before
- * then strike a small cow's eye at the end of the fissure with the punch and the drawing pin: the fissure will then creep into the hole all by itself, or you help it by knocking a bit from the rear side.

5. 3. The sealing of fissure borings is carried out as described in section 4.18.:

5. 4. Filling fissures with resin:

- * it is done by use of capillary action. Drop resin into the fissure. Start at the end of it, and always wait until the resin has completely penetrated into the fissure, then drop into the next spot
- * the fissure is filled by use of an adhesive tape which is stuck over the fissure. For the final boring procedure, a hole is pierced through the tape. The tool-holder is set up, the filling cylinder is screwed in, 0.4 ml resin is put into it, the injector-screw is screwed in. Now put the fissure under pressure.
- * a third method is to fill resin into the cylinder held upside down, to apply the cylinder on the fissure spot and then to exert pressure on the resin. While continuing to screw the injector screw in, move the cylinder along the fissure as the resin penetrates it.

TABLE OF CONTENTS

1. 0.	General information on damage caused by stones on laminated windshields of motor vehicles, and on roger's windshield repair system	1
1. 1.	The problem	1
1. 2.	The solution	1
1. 3.	The method	1+2
1. 4.	Typical examples of damage to laminated glass	2
1. 5.	roger's repair process (in simplified form)	2
1. 6.	Results of the repair	2
1. 7.	What accounts for the outstanding quality of roger's repairs?	3
1. 8.	roger's technology and development today	3
2. 0.	Technical data about laminated glass and the effects of stone impacts on them	4
2. 1.	What are laminated windshields? What is their purpose and use?	4
2. 2.	Technical data about laminated glass in motor vehicles	4
2. 3.	The impact of stones on laminated windshields of motor vehicles and its effects	4
2. 4.	Most frequent types of damage on laminated windshields	5
3. 0.	Theory and requirements of repairs	5
3. 1.	General physics	5
3. 2.	Liability of the repair shop in case of failure to repair the damage or of fissure formation during the repair	5+6
3. 3.	Required repair results	6
3. 4.	Requirements of the repair shop	6
4. 0.	The repair procedure in practice	7
4. 1.	Preliminary inspection - examination of the basic conditions	7
4. 2.	Legal provisions excluding repairs	7+8
4. 3.	Working temperature during the repair	8
4. 4.	Careful inspection of the damage	8
4. 5.	Preparations and preliminary work	8+9
4. 6.	Cleaning and preparing damp, dirty or old damaged spots with the wash primer	9+10
4. 7.	Mounting the tool-holder	10
4. 8. 1.	Mounting the filling-resin cylinder	11+12
4. 8. 2.	Use of the bus adapter	12
4. 9.	Injection of filling-resin	13
4. 10.	Putting the damaged spot under vacuum	13+14
4. 11.	Repetition of pressure and vacuum procedures	14
4. 12.	Visual inspection from all sides	14
4. 13.	Difficult cases: You can't get the air out completely - what can you do?	14-16
4. 14.	Boring of damages caused by stones and striking them with punch and drawing pin	17
4. 15.	Final inspection	17+18
4. 16.	Hardening of the filling resin	18
4. 17.	Impact-spot or surface sealing with the finishing resin	18+19
4. 18.	Sealing of boring holes	19
4. 19.	Final work	20
5. 0.	Repair of fissures	20
5. 1.	General information	20
5. 2.	Boring of fissures	20+21
5. 3.	Sealing of fissure borings	21
5. 4.	Filling fissures with resin	21-23
6. 0.	Types of damage / special repair and boring instructions	24
7. 0.	Summary of the instructions for use	25-28
	Table of contents	29

Notizen
Notes

Notizen
Notes